

Double Star Flexicube

by Dave Brill (c) 1989

an origami interpretation of Noaki Yoshimoto's Cube

see http://www1.ttcn.ne.jp/a-nishi/y_cube/z_y_cube.html

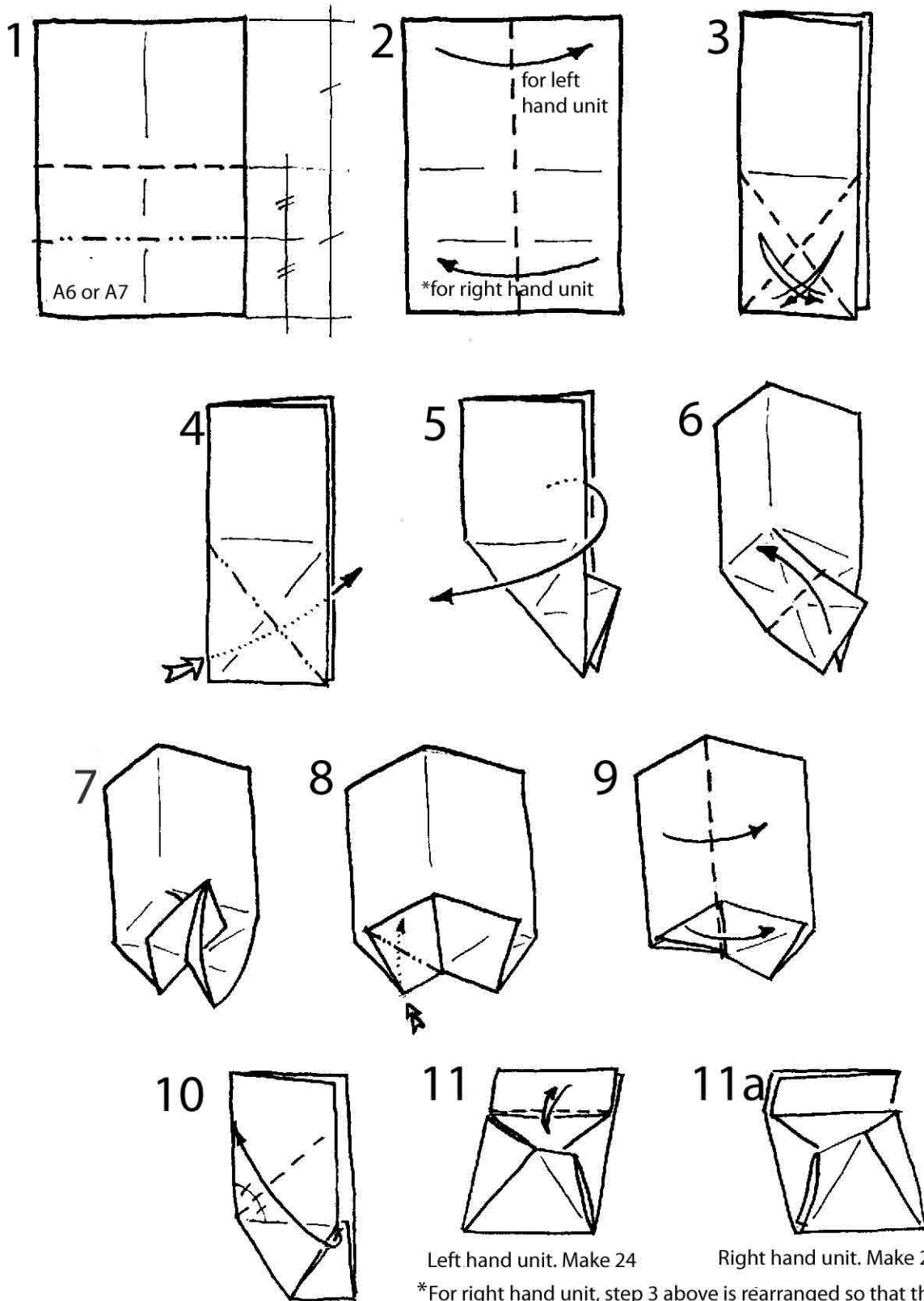

Left hand unit. Make 24

Right hand unit. Make 24

*For right hand unit, step 3 above is rearranged so that the folded edge is on the right. Remaining drawings should be seen as "mirror images"

12

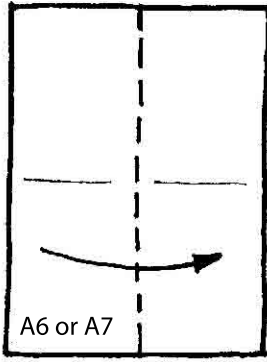

13

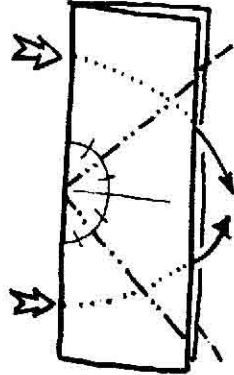

14

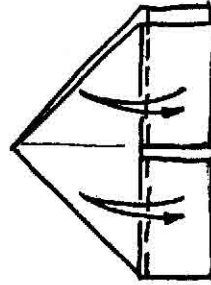

15

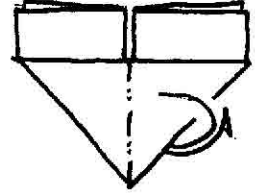

16

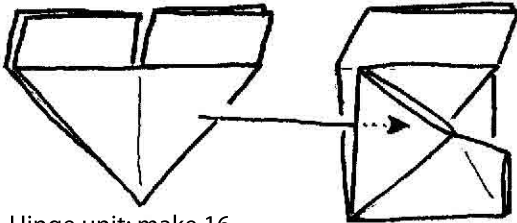

Hinge unit: make 16

17

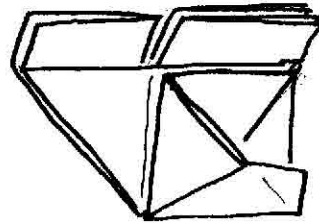

Method of connecting the hinge unit to a left hand unit.
A similar principle is used to connect the hinge to a right hand unit.

18

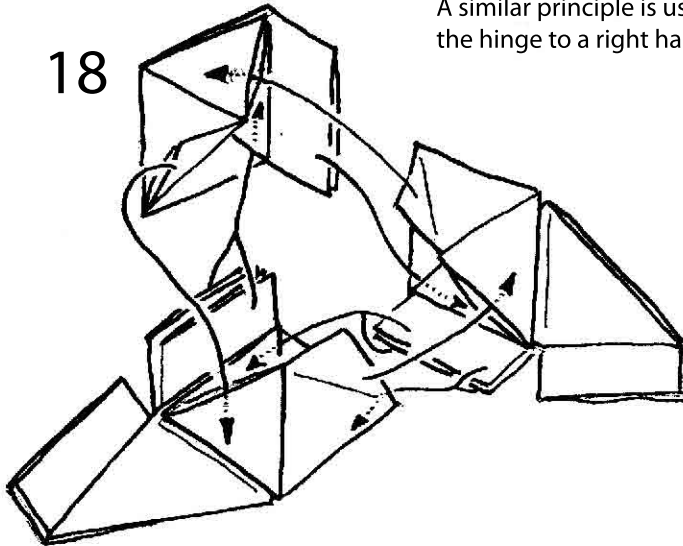

Construction of 3 left hand units and 2 hinge units to form a half cube cluster.

The positioning of the 2 hinge units varies. See next drawing.

19

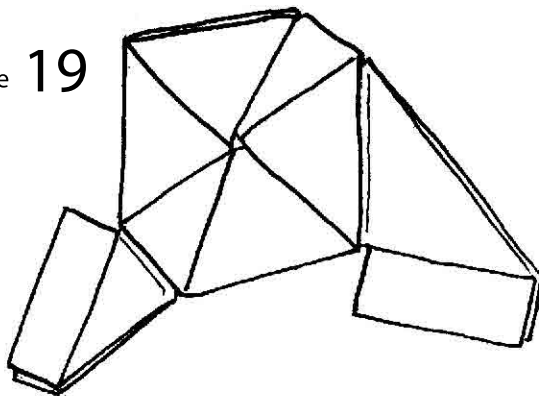

8 half cube clusters linked by 8 hinge units

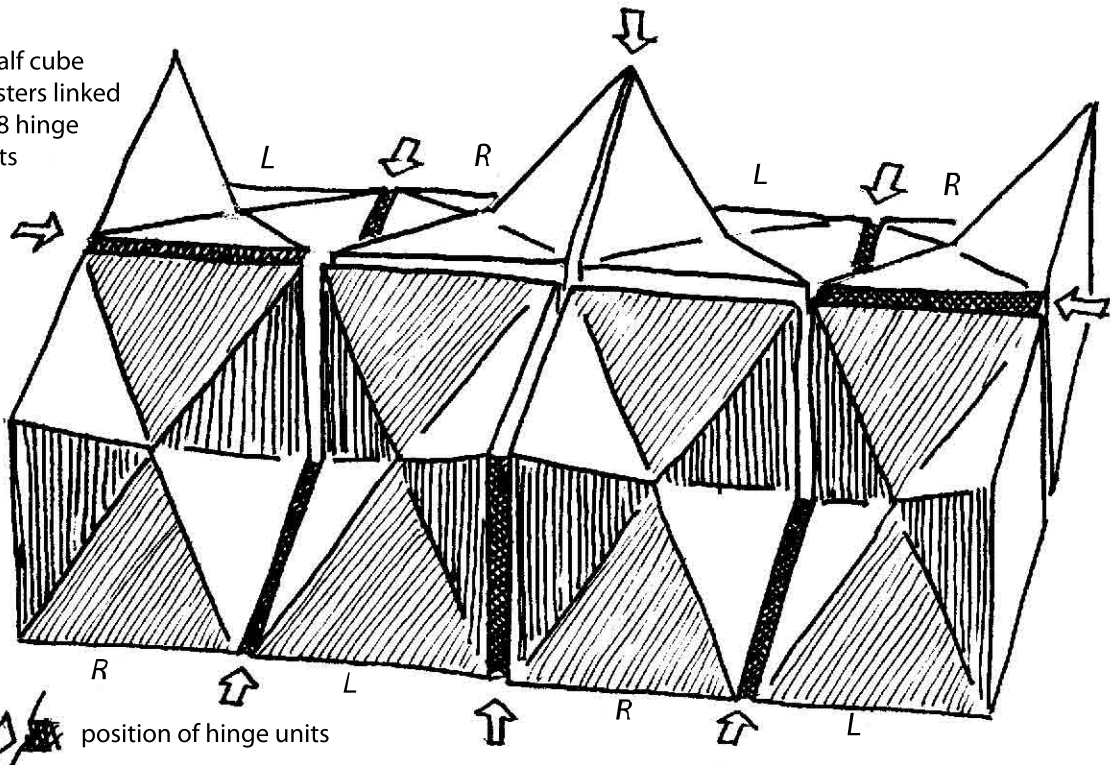

R indicates cluster made from
L right- or left- hand units

Two of these constructions are required

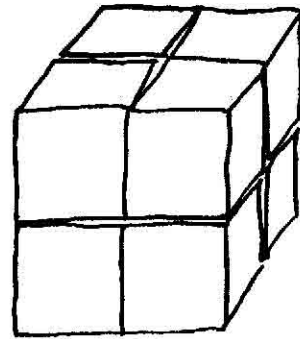
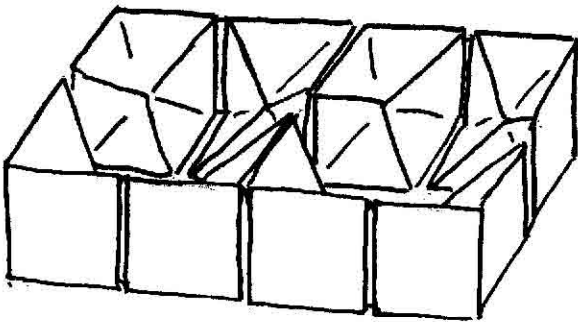

Some of the shapes made by flexing the construction

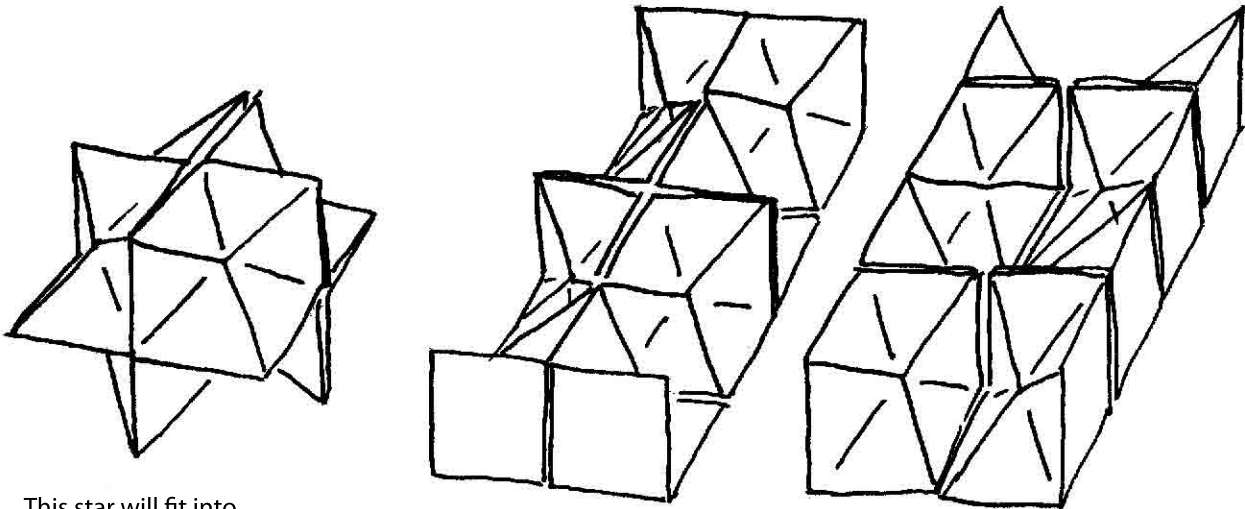

This star will fit into the cube (above right)

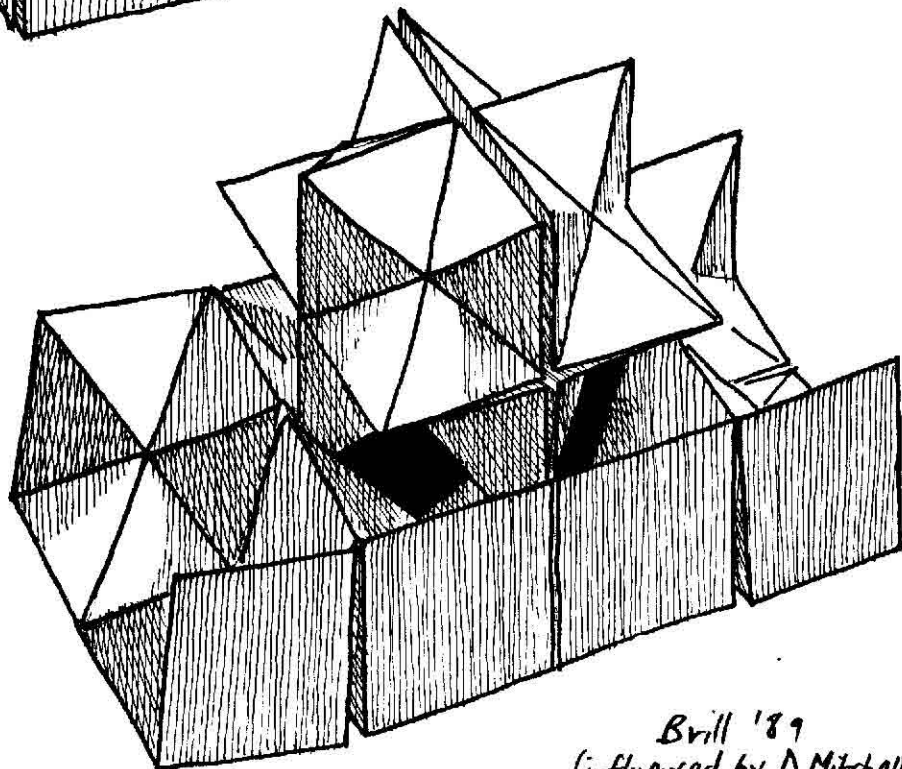
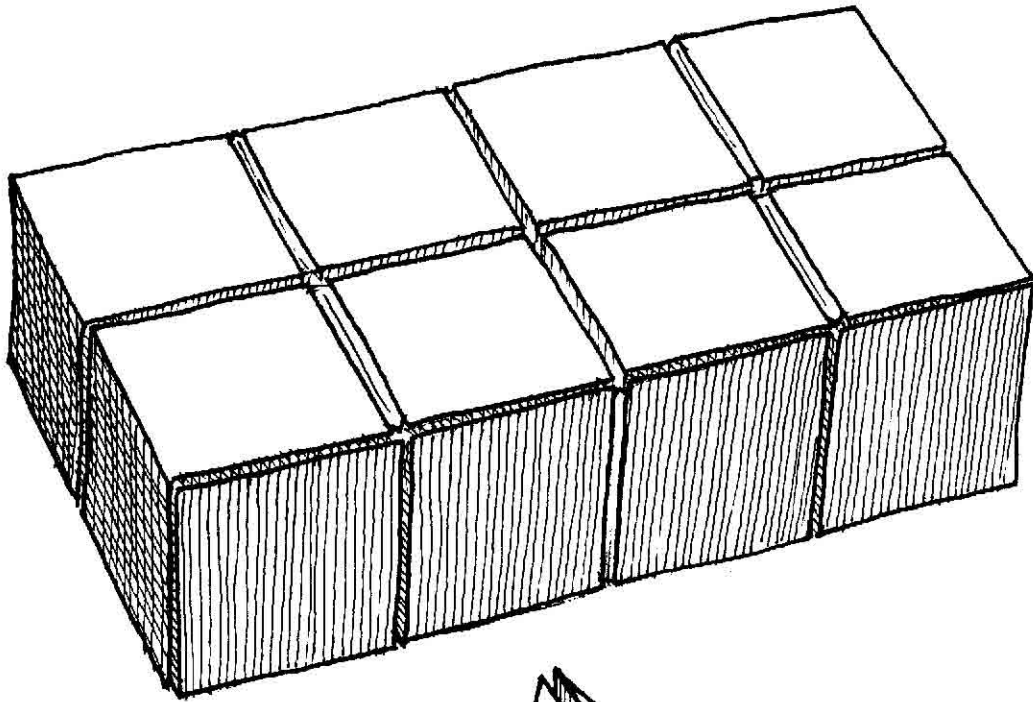

Brill '89
(influenced by D. Mitchell)